

MHP-2040A500A

[General Specification]

Item		Description
Part Number		MHP-2040A500A
Material of Container		Aluminium 1050
Wick Structure		Groove
Working Fluid		Acetone
Dimension	Thickness	2.0 mm
	Width	40.0 mm
	Length	500.0 mm
Weight		15.8 g (Average)
Q _{max}	Horizontal	45.0 W (at 50°C)
	Vertical	175.0 W (at 50°C)
Typical Thermal Resistance		<0.3°C / W (Average)
Operating Inclination, ϕ		0 ~ 90°
Leak Temperature Criterion		-40~100°C

[Scope]

This specification details the requirements and applications for 2.0mm x40.0mm x500.0mm.

[Dimensions]

The dimensional attributes of this shall conform to the following figure.

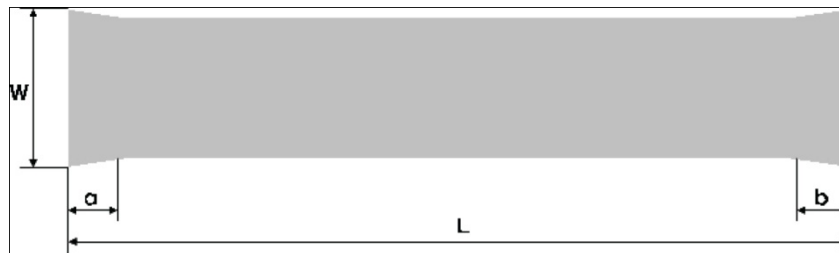

Thickness (t)	Width (W)	Length (L)	Ineffective Length (a)	Ineffective Length (b)
2.0 mm	40.0 mm	500.0 mm	2.5 mm	2.5 mm

[Material]

Container	Aluminium 1050
Working Fluid	Acetone
Surface Treatment	None

AMEC Thermasol

1-2 Steam Mill Lane, Great Yarmouth, Norfolk, NR31 0HP

Telephone: +44(0) 1493 668622 Fax: +44(0) 1493 668623

Email: sales@amecthermasol.co.uk Website: www.amecthermasol.co.uk

Test Data - MHP-2040A150A

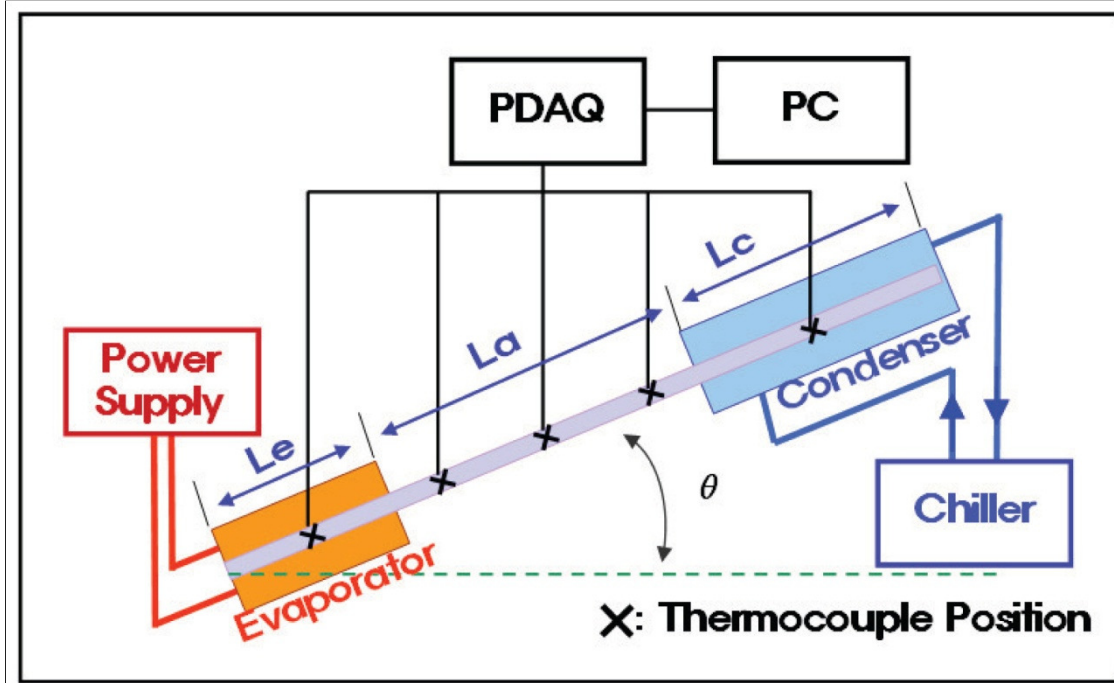

Qmax Test Apparatus

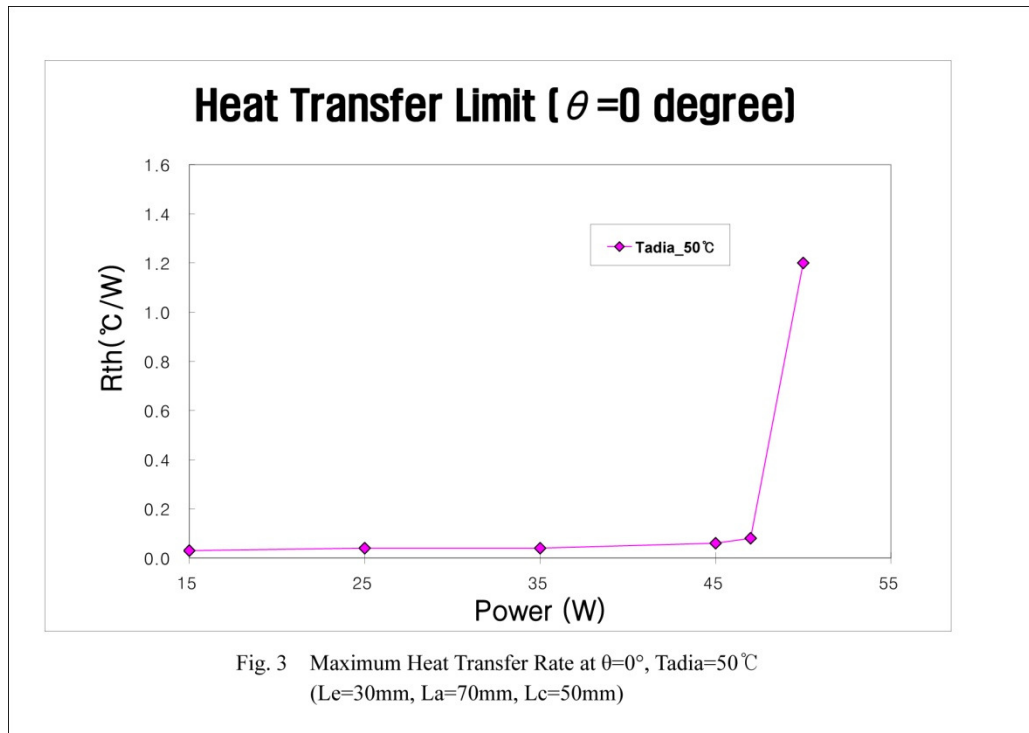

AMEC Thermasol

1-2 Steam Mill Lane, Great Yarmouth, Norfolk, NR31 0HP

Telephone: +44(0) 1493 668622 **Fax:** +44(0) 1493 668623

Email: sales@amecthermasol.co.uk **Website:** www.amecthermasol.co.uk

Test Data - MHP-2040A150A

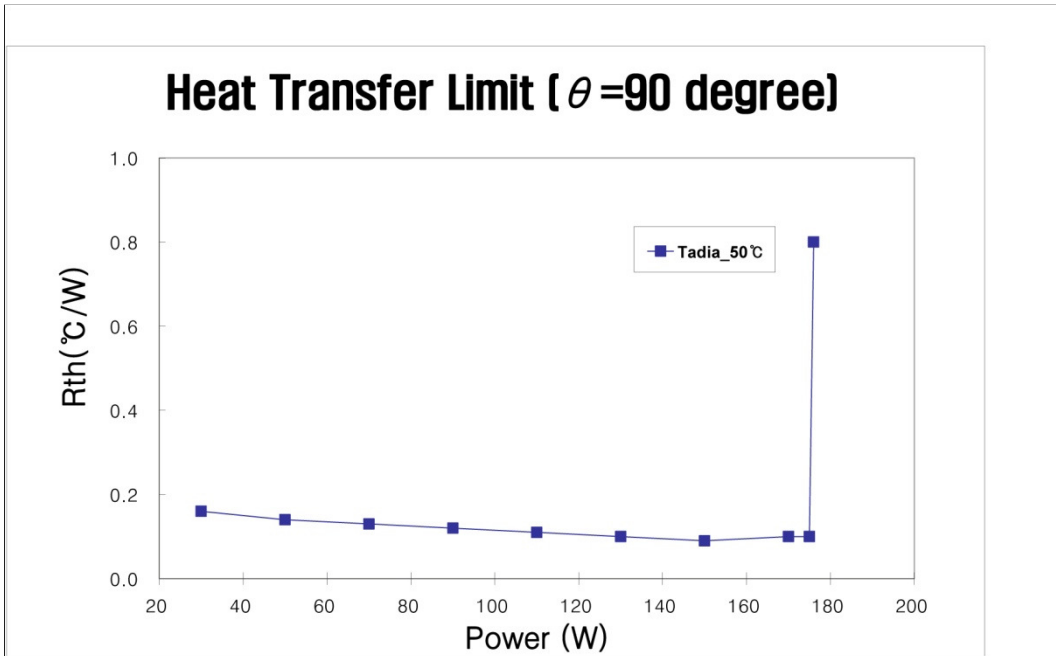

Fig. 4 Maximum Heat Transfer Rate at $\theta=90^\circ$, Tadial=50°C
 (Le=30mm, La=70mm, Lc=50mm)

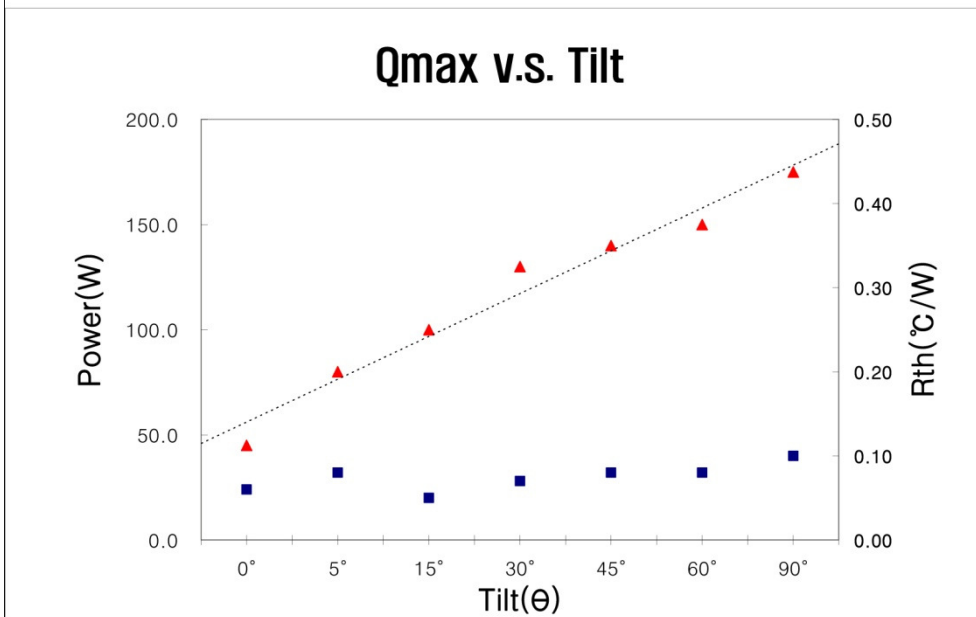

Fig. 5 Maximum Heat Transfer Rate vs. Inclination at Tadial=50°C
 (Le=30mm, La=70mm, Lc=50mm)

AMEC Thermasol

1-2 Steam Mill Lane, Great Yarmouth, Norfolk, NR31 0HP

Telephone: +44(0) 1493 668622 Fax: +44(0) 1493 668623

Email: sales@amecthermasol.co.uk Website: www.amecthermasol.co.uk

Test Data - MHP-2040A150A

[High Temperature Leak Test]

Every manufactured S sealed with a mechanical pinch system. The mechanical pinch of container results in a cold weld seal. The average leak temperature is about 170°C.

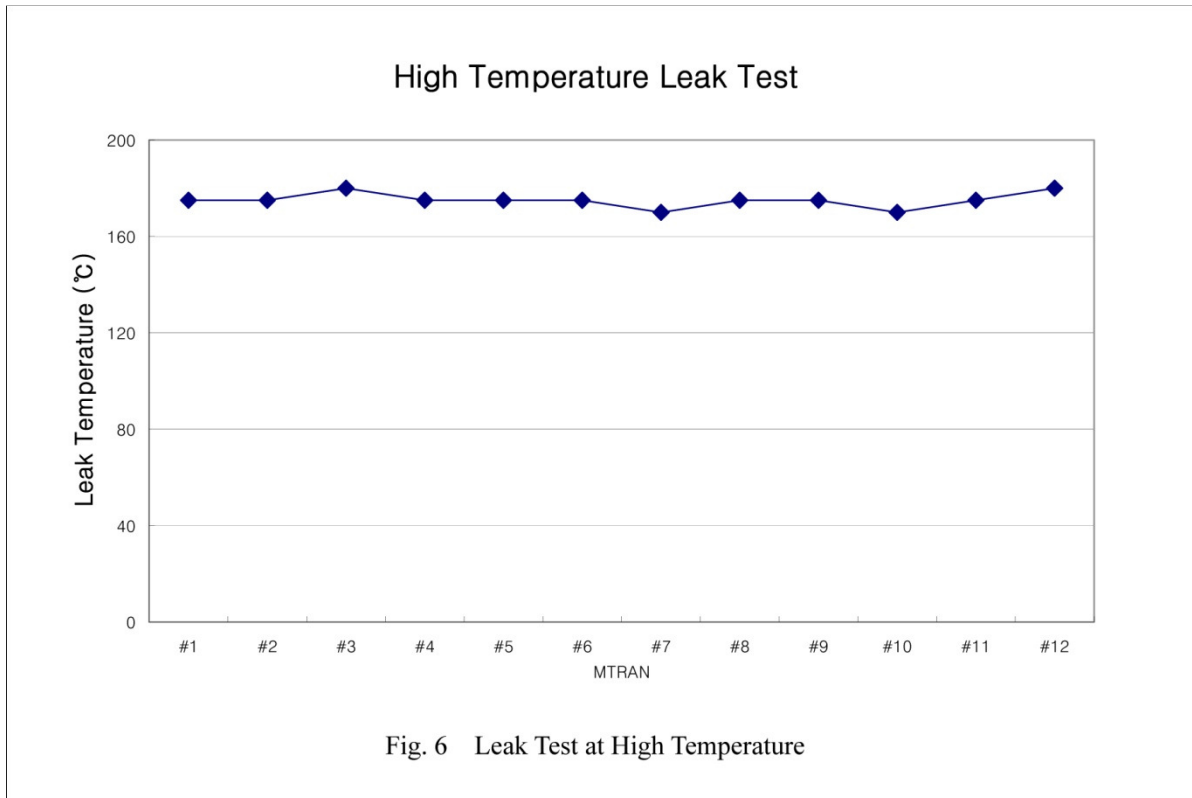

AMEC Thermasol

1-2 Steam Mill Lane, Great Yarmouth, Norfolk, NR31 0HP

Telephone: +44(0) 1493 668622 **Fax:** +44(0) 1493 668623

Email: sales@amecthermasol.co.uk **Website:** www.amecthermasol.co.uk

Test Data - MHP-2040A150A

[Thermal Response Test]

Every manufactured must pass the thermal response test to ensure its operation and Vacuum and leakage check. The experimental test bench is schematically shown in Fig.6. Water bath temperature, T_w is set at 50°C and the temperature of other end, T_t is measured immediately after it is placed vertically into the water bath. The criterion for acceptance is 5°C ($T_w - T_t$).

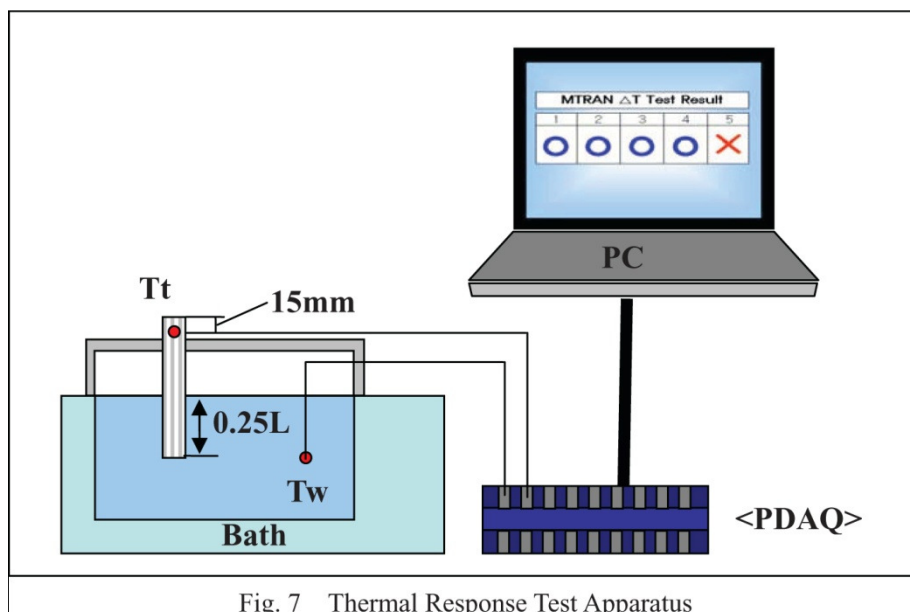

Fig. 7 Thermal Response Test Apparatus

AMEC Thermasol

1-2 Steam Mill Lane, Great Yarmouth, Norfolk, NR31 0HP

Telephone: +44(0) 1493 668622 Fax: +44(0) 1493 668623

Email: sales@amecthermasol.co.uk Website: www.amecthermasol.co.uk